

Rod Seals

Hallite

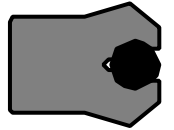

513

TECHNICAL DETAILS		METRIC	INCH
OPERATING CONDITIONS			
MAXIMUM SPEED	0.5 m/sec	1.5 ft/sec	
TEMPERATURE RANGE	-40°C + 110°C	-40°F + 230°F	
MAXIMUM PRESSURE	350 bar	5000 p.s.i.	
MAXIMUM EXTRUSION GAP			
(1/4" section and above)			
PRESSURE bar	160	250	350
PRESSURE p.s.i.	2400	3750	5000
MAXIMUM GAP in	0.024	0.020	0.016
SURFACE ROUGHNESS			
DYNAMIC SEALING FACE ϕd_1	μmRa 0.1 ↔ 0.4	μmRt 4 max	μinCLA 4 ↔ 16
STATIC SEALING FACE ϕD_1	1.6 max	10 max	μinRMS 5 ↔ 18
STATIC HOUSING FACES L_1	3.2 max	16 max	63 max 70 max
			125 max 140 max
CHAMFERS & RADII			
GROOVE SECTION S in	0.125	0.187	0.250
MIN CHAMFER C in	0.093	0.093	0.125
MAX FILLET RAD r_1 in	0.008	0.008	0.016
MAX FILLET RAD r_2 in	0.016	0.016	0.032
	0.032	0.047	0.047
	0.047	0.047	0.047
TOLERANCES			

Figures show the maximum permissible gap all on one side using minimum rod ϕ and maximum clearance ϕ .

0.125	0.187	0.250	0.312	0.375	0.500
0.093	0.093	0.125	0.156	0.187	0.187
0.008	0.008	0.016	0.032	0.032	0.032
0.016	0.016	0.032	0.047	0.047	0.047

Please refer to specified tolerances in the introduction
- Housing & installation data - Hallite 500 Series

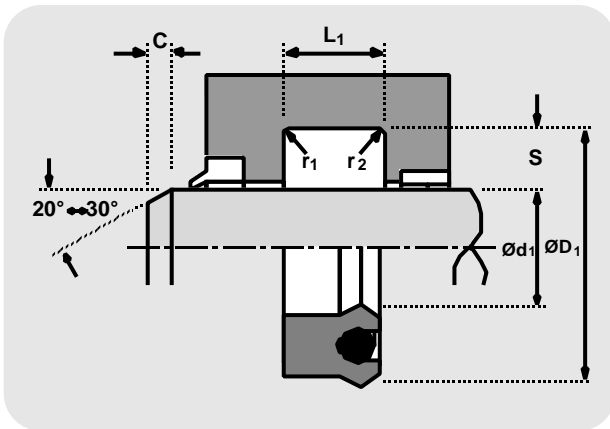

DESIGN

The Hallite 513 is a standard profile loaded U cup utilising a polyurethane or polyester shell energised by a high specification resilient O ring.

At zero or low pressure, the O ring helps to increase the sealing force preventing any bypass. As pressure rises the sealing force increases and the O ring provides complete lip actuation under most conditions. The precision trimmed sealing lips ensure optimum sealing action.

FEATURES

- FLEXIBLE FOR EASY INSTALLATION
- EXCELLENT RESISTANCE TO ABRASION
- POSITIVE LIP ACTUATION
- KNIFE TRIMMED PRECISION SEALING LIPS
- COMPACT HOUSING
- WIDE RANGE OF SIZES
- MATERIAL OPTIONS

MATERIALS

Seal material - O-Ring	last digit of part number
Standard material:	
Polyurethane - NBR	----- 10
Material options:	
Polyester - NBR	----- 11
Polyester - FKM	----- 12

Rod seals

Hallite 513

inch

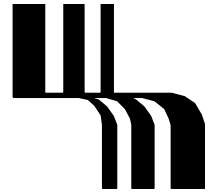
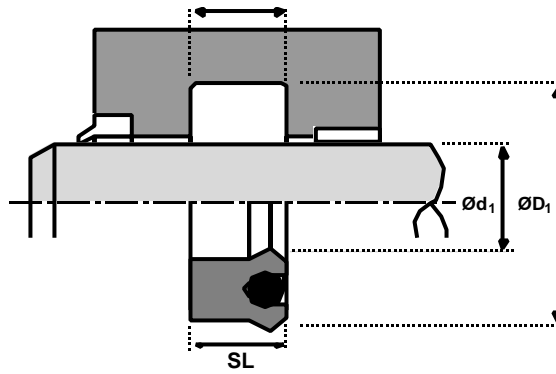

Ød ₁	ØD ₁	SL	L ₁	STD. REF.	PART No.
-----------------	-----------------	----	----------------	-----------	----------

1/8 CROSS SECTION

.250	.500	.187	.207	12500250-187B	8845910
.250	.500	.250	.275	12500250-250B	8878510
.375	.625	.250	.275	12500375-250B	8823810
.437	.687	.250	.275	12500437-250B	8846910
.500	.750	.250	.275	12500500-250B	8834010
.625	.875	.187	.207	12500625-187B	8848710
.625	.875	.250	.275	12500625-250B	8834110
.750	1.000	.250	.275	12500750-250B	8834210
.875	.125	.250	.275	12500875-250B	8845310
.875	1.125	.250	.275	12500937-250B	8845310
1.000	1.250	.187	.207	12501000-187B	8860110
1.000	1.250	.250	.275	12501000-250B	8834410
1.062	1.312	.250	.275	12501062-250B	8847510
1.125	1.375	.125	.275	12501125-125B	8899910
1.125	1.375	.250	.275	12501125-250B	8855610
1.125	1.375	.312	.344	12501125-312B	8848810
1.187	1.437	.250	.275	12501187-250B	8848910
1.250	1.500	.187	.207	12501250-187B	8860210
1.250	1.500	.250	.275	12501250-250B	8834710
1.375	1.625	.187	.207	12501375-187B	8860310
1.375	1.625	.250	.275	12501375-250B	8834910
1.437	1.687	.250	.275	12501437-250B	8849010
1.500	1.750	.250	.275	12501500-250B	8835210
1.625	1.875	.187	.207	12501625-187B	8849110
1.625	1.875	.250	.275	12501625-250B	8873110
1.750	2.000	.250	.275	12501750-250B	8835610
1.875	2.125	.187	.207	12501875-187B	8845810
1.875	2.125	.250	.275	12501875-250B	8845410
2.000	2.250	.187	.207	12502000-187B	8860410
2.000	2.250	.250	.275	12502000-250B	8873210
2.500	2.750	.250	.275	12502500-250B	8902210
2.875	3.125	.250	.275	12502875-250B	8844710
3.875	4.125	.250	.275	12503875-250B	8845510
4.875	5.125	.250	.275	12504875-250B	8845610

3/16 CROSS SECTIONB

.500	.875	.250	.275	18700500-250B	8848010
.500	.875	.312	.344	18700500-312B	8852910
.750	1.125	.187	.207	18700750-187B	8849810
.750	1.125	.250	.275	18700750-250B	8846010
.750	1.125	.312	.344	18700750-312B	8834310

Ød ₁	ØD ₁	SL	L ₁	STD. REF.	PART No.
-----------------	-----------------	----	----------------	-----------	----------

.750	1.125	.375	.413	18700750-375B	8855810
.875	1.250	.312	.344	18700875-312B	8900210
1.000	1.375	.187	.207	18701000-187B	8806110
1.000	1.375	.250	.275	18701000-250B	8860510
1.000	1.375	.312	.344	18701000-312B	8834510
1.062	1.437	.312	.344	18701062-312B	8850010
1.125	1.500	.250	.275	18701125-250B	8844910
1.125	1.500	.312	.344	18701125-312B	8834610
1.187	1.600	.312	.344	18701187-312B	8902310
1.250	1.625	.250	.275	18701250-250B	8860610
1.250	1.625	.312	.344	18701250-312B	8834810
1.250	1.625	.375	.413	18701250-375B	8860710
1.375	1.750	.250	.275	18701375-250B	8844710
1.375	1.750	.312	.344	18701375-312B	8835010
1.375	1.750	.375	.413	18701375-375B	8835110
1.500	1.875	.187	.275	18701500-187B	8851510
1.500	1.875	.250	.275	18701500-250B	8835310
1.500	1.875	.312	.344	18701500-312B	8849710
1.500	1.875	.375	.413	18701500-375B	8835410
1.500	1.875	.406	.447	18701500-406B	8848110
1.625	2.000	.250	.275	18701625-250B	8868410
1.625	2.000	.312	.344	18701625-312B	8864210
1.625	2.000	.375	.413	18701625-375B	8835510
1.750	2.125	.230	.250	18701750-230B	8852010
1.750	2.125	.312	.344	18701750-312B	8865410
1.750	2.125	.375	.413	18701750-375B	8835710
1.875	2.250	.375	.413	18701875-375B	8835810
2.000	2.375	.230	.250	18702000-230B	8806210
2.000	2.375	.250	.275	18702000-250B	8868110
2.000	2.375	.312	.344	18702000-312B	8860810
2.000	2.375	.375	.413	18702000-375B	8835910
2.125	2.500	.250	.275	18702125-250B	8845010
2.125	2.500	.375	.413	18702125-375B	8836010
2.250	2.625	.312	.344	18702250-312B	8860910
2.250	2.625	.375	.413	18702250-375B	8873310
2.375	2.750	.375	.413	18702375-375B	8861010
2.500	2.875	.375	.413	18702500-375B	8836210
2.625	3.000	.250	.275	18702625-250B	8868510
2.625	3.000	.312	.344	18702625-312B	8864310
2.625	3.000	.375	.413	18702625-375B	8836310
2.750	3.125	.187	.207	18702750-187B	8849910
2.750	3.125	.312	.344	18702750-312B	8846110

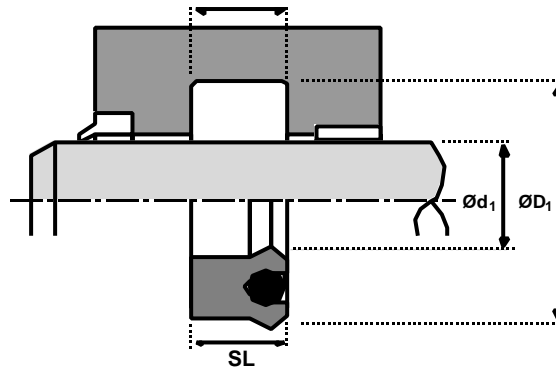
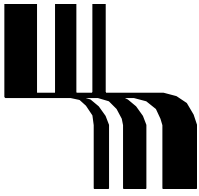

Rod seals

Hallite 513 inch

$\varnothing d_1$	$\varnothing D_1$	SL	L_1	STD. REF.	PART No.
2.750	3.125	.375	.413	18702750-375B	8836410
2.875	3.250	.375	.413	18702875-375B	8861110
3.000	3.375	.187	.207	18703000-187B	8806710
3.000	3.375	.250	.275	18703000-250B	8868210
3.000	3.375	.312	.344	18703000-312B	8861210
3.000	3.375	.375	.413	18703000-375B	8836510
3.125	3.500	.250	.275	18703125-250B	8845110
3.125	3.500	.375	.413	18703125-375B	8836610
3.250	3.625	.312	.344	18703250-312B	8861310
3.250	3.625	.375	.413	18703250-375B	8873410
3.375	3.750	.375	.413	18703375-375B	8836710
3.500	3.875	.375	.413	18703500-375B	8836810
3.625	4.000	.250	.275	18703625-250B	8868610
3.625	4.000	.312	.344	18703625-312B	8864410
3.625	4.000	.375	.413	18703625-375B	8836910
3.750	4.125	.187	.207	18703750-187B	8850210
3.750	4.125	.312	.344	18703750-312B	8846210
3.750	4.125	.375	.413	18703750-375B	8837010
3.875	4.250	.375	.413	18703875-375B	8861410
4.000	4.375	.187	.207	18704000-187B	8820010
4.000	4.375	.250	.275	18704000-250B	8868310
4.000	4.375	.312	.344	18704000-312B	8861510
4.000	4.375	.375	.413	18704000-375B	8837110
4.125	4.500	.250	.275	18704125-250B	8845210
4.125	4.500	.375	.413	18704125-375B	8837210
4.250	4.625	.312	.344	18704250-312B	8861610
4.250	4.625	.375	.413	18704250-375B	8837310
4.375	4.750	.375	.413	18704375-375B	8861710
4.500	4.875	.375	.413	18704500-375B	8837510
4.625	5.000	.250	.275	18704625-250B	8868710
4.625	5.000	.312	.344	18704625-312B	8864510
4.625	5.000	.375	.413	18704625-375B	8837610
4.750	5.125	.375	.413	18704750-375B	8846610
4.875	5.250	.375	.413	18704875-375B	8861810
5.000	5.375	.375	.413	18705000-375B	8842510

1/4 CROSS SECTION

.500	1.000	.375	.413	25000500-375B	8837710
.625	1.125	.312	.344	25000625-312B	8849210
.750	1.250	.375	.413	25000750-375B	8837810
.875	1.375	.312	.344	25000875-312B	8830210
.875	1.375	.375	.413	25000875-375B	8864610

$\varnothing d_1$	$\varnothing D_1$	SL	L_1	STD. REF.	PART No.
1.000	1.500	.375	.413	25001000-375B	8837910
1.125	1.625	.250	.413	25001125-250B	8804910
1.125	1.625	.375	.413	25001125-375B	8856110
1.250	1.750	.375	.413	25001250-375B	8838110
1.375	1.875	.375	.413	25001375-375B	8878610
1.375	2.250	.250	.413	25001500-312B	8805610
1.500	2.000	.312	.344	25001500-375B	8867710
1.500	2.000	.375	.413	25001625-375B	8838310
1.625	2.125	.375	.413	25001750-250B	8849610
1.750	2.250	.375	.413	25001750-375B	8838510
1.875	2.375	.375	.413	25001875-375B	8859410
2.000	2.500	.250	.413	25002000-250B	8856010
2.000	2.500	.375	.413	25002000-375B	8838610
2.125	2.625	.375	.413	25002125-250B	8856310
2.175	2.625	.250	.413	25002125-375B	8805810
2.250	2.750	.375	.413	25002250-375B	8838710
2.375	2.875	.375	.413	25002375-375B	8850110
2.375	2.875	.562	.413	25002375-562B	8900610
2.500	3.000	.312	.344	25002500-312B	8867810
2.500	3.000	.375	.413	25002500-375B	8839010
2.625	3.125	.375	.413	25002625-375B	8849310
2.750	3.250	.250	.413	25002750-250B	8805910
2.750	3.250	.375	.413	25002750-375B	8839110
2.875	3.375	.562	.619	25002875-375B	8900610
3.000	3.500	.375	.413	25003000-375B	8839310
3.000	3.500	.500	.550	25003000-500B	8842110
3.000	3.500	.562	.619	25003000-562B	8852210
3.125	3.625	.250	.413	25003125-250B	8848510
3.125	3.625	.375	.413	25003125-375B	8856210
3.250	3.750	.375	.413	25003250-375B	8839410
3.375	3.875	.375	.413	25003375-375B	8849410
3.375	3.875	.562	.619	25003375-562B	8900710
3.500	4.000	.312	.344	25003500-312B	8867910
3.500	4.000	.375	.413	25003500-375B	8839510
3.625	4.125	.375	.413	25003625-375B	8849510
3.750	4.250	.250	.413	25003750-250B	8846110
3.750	4.250	.375	.413	25003750-375B	8839710
3.750	4.250	.562	.619	25003750-562B	8839810
3.875	4.375	.375	.413	25003875-375B	8832510
4.000	4.500	.375	.413	25004000-375B	8840010
4.000	4.500	.500	.550	25004000-500B	8867510
4.000	4.500	.562	.619	25004000-562B	8840110

Rod seals

Hallite 513

inch

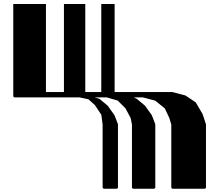
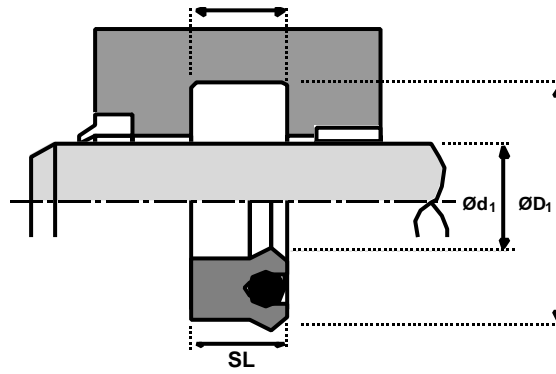

Ød ₁	ØD ₁	SL	L ₁	STD. REF.	PART No.
4.125	4.625	.250	.413	25004125-250B	8806010
4.125	4.625	.375	.413	25004125-375B	8856410
4.250	4.750	.375	.413	25004250-375B	8840210
4.375	4.875	.250	.413	25004375-250B	8848310
4.375	4.875	.562	.616	25004375-562B	8900510
4.500	5.000	.250	.344	25004500-250B	8817110
4.500	5.000	.312	.344	25004500-312B	8868010
4.500	5.000	.375	.413	25004500-375B	8840510
4.500	5.000	.500	.550	25004500-500B	8864710
4.500	5.000	.562	.619	25004500-562B	8840610
4.625	5.125	.250	.413	25004500-250B	8848410
4.750	5.250	.375	.413	25004750-375B	8861910
4.750	5.250	.500	.550	25004750-500B	8846310
4.750	5.250	.562	.619	25004750-562B	8840910
4.875	5.375	.375	.413	25004875-375B	8832910
5.000	5.500	.375	.413	25005000-375B	8841010
5.000	5.500	.500	.550	25005000-500B	8866810
5.000	5.500	.562	.619	25005000-562B	8841110
5.250	5.750	.562	.619	25005250-562B	8862010
5.500	6.000	.375	.413	25005500-375B	8841310
5.500	6.000	.500	.413	25005500-500B	8833610
5.500	6.000	.562	.619	25005500-562B	8841410
5.750	6.250	.375	.413	25005750-375B	8866410
5.750	6.250	.562	.619	25005750-562B	8841610
6.000	6.500	.375	.413	25006000-375B	8852310
6.000	6.500	.500	.550	25006000-500B	8867610
6.000	6.500	.562	.619	25006000-562B	8841710
6.500	7.000	.250	.275	25006500-250B	8899410
6.500	7.000	.375	.413	25006500-375B	8852610
6.500	7.000	.500	.550	25006500-500B	8846410
6.500	7.000	.562	.619	25006500-562B	8841910
6.750	7.250	.375	.413	25006750-375B	8865910
6.750	7.250	.500	.550	25006750-500B	8866010
6.750	7.250	.562	.619	25006750-562B	8866310
7.000	7.500	.375	.413	25007000-375B	8852410
7.000	7.500	.500	.550	25007000-500B	8842410
7.000	7.500	.562	.619	25007000-562B	8877910
7.250	7.750	.562	.619	25007250-562B	8862110
7.500	8.000	.375	.413	25007500-375B	8852510
7.500	8.000	.500	.550	25007500-500B	8833810
7.500	8.000	.562	.619	25007500-562B	8852810
8.000	8.500	.250	.275	25008000-250B	8899710

Ød ₁	ØD ₁	SL	L ₁	STD. REF.	PART No.
8.000	8.500	.562	.619	25008000-562B	8842310
8.500	9.000	.375	.413	25008500-375B	8852710
8.500	9.000	.500	.550	25008500-500B	8833910
8.500	9.000	.562	.619	25008500-562B	8853010

5/16 CROSS SECTION

Ød ₁	ØD ₁	SL	L ₁	STD. REF.	PART No.
1.000	1.625	.375	.413	31201000-375B	8828310
1.000	1.625	.500	.550	31201000-500B	8838010
1.125	1.750	.500	.550	31201125-500B	8879810
1.250	1.875	.312	.550	31201250-312B	8809810
1.250	1.875	.500	.550	31201250-500B	8838210
1.375	2.000	.312	.550	31201375-312B	8825110
1.375	2.000	.500	.550	31201375-500B	8873510
1.500	2.125	.375	.413	31201500-375B	8846510
1.500	2.125	.500	.550	31201500-500B	8838410
1.750	2.375	.375	.413	31201750-375B	8868810
1.750	2.375	.500	.550	31201750-500B	8873610
1.875	2.500	.500	.550	31201875-500B	8873710
2.000	2.625	.500	.550	31202000-500B	8873810
2.000	2.625	.562	.619	31202000-562B	8862210
2.125	2.750	.500	.550	31202125-500B	8879910
2.125	2.750	.625	.688	31202125-625B	8864810
2.250	2.875	.312	.550	31202250-312B	8816310
2.250	2.875	.500	.550	31202250-500B	8838810
2.375	3.000	.031	.550	31202375-312B	8827210
2.375	3.000	.500	.550	31202375-500B	8838910
2.500	3.125	.375	.413	31202500-375B	8836110
2.500	3.125	.500	.550	31202500-500B	8873910
2.750	3.375	.375	.413	31202750-375B	8868910
2.750	3.375	.500	.550	31202750-500B	8839210
2.875	3.500	.500	.550	31202875-500B	8874010
3.000	3.625	.375	.413	31203000-375B	8828510
3.000	3.625	.500	.550	31203000-500B	8874110
3.125	3.750	.500	.550	31203125-500B	8869810
3.250	3.875	.425	.550	31203250-312B	8820110
3.250	3.875	.500	.550	31203250-500B	8869710
3.375	4.000	.312	.550	31203375-312B	8827410
3.375	4.000	.500	.550	31203375-500B	8874210
3.500	4.125	.375	.413	31203500-375B	8837410
3.500	4.125	.500	.550	31203500-500B	8874310
3.750	4.375	.375	.413	31203750-375B	8869010
3.750	4.375	.500	.550	31203750-500B	8874410

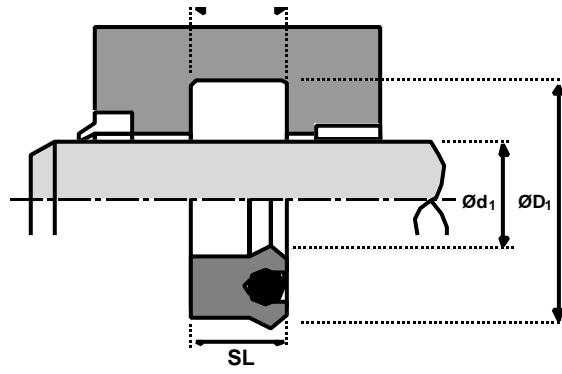
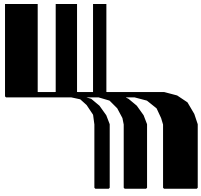

Rod seals

Hallite 513

inch

$\varnothing d_1$	$\varnothing D_1$	SL	L_1	STD. REF.	PART No.
3.875	4.500	.500	.550	31203875-500B	8839910
4.000	4.625	.500	.550	31204000-500B	8874510
4.000	4.625	.562	.619	31204000-562B	8862310
4.125	4.750	.500	.550	31204125-500B	8869610
4.125	4.750	.625	.688	31204125-625B	8869510
4.250	4.875	.312	.550	31204250-312B	8821610
4.250	4.875	.500	.550	31204250-500B	8869410
4.375	5.000	.312	.550	31204375-312B	8827610
4.375	5.000	.500	.550	31204375-500B	8874610
4.375	5.000	.625	.688	31204375-625B	8840410
4.500	5.125	.375	.413	31204500-375B	8840710
4.500	5.125	.625	.688	31204500-625B	8840810
4.750	5.375	.500	.550	31204750-500B	8869310
4.750	5.375	.625	.688	31204750-625B	8862410
5.000	5.625	.625	.688	31205000-625B	8874710
5.250	5.875	.625	.688	31205250-625B	8862510
5.375	6.000	.625	.688	31205375-625B	8841210
6.000	6.625	.625	.688	31206000-625B	8862610
6.375	7.000	.625	.688	31206375-625B	8841810
6.500	7.125	.625	.688	31206500-625B	8869110
6.750	7.375	.625	.688	31206750-625B	8862710
7.000	7.625	.625	.688	31207000-625B	8854810
7.250	7.875	.625	.688	31207250-625B	8862810
7.375	8.000	.500	.550	31207375-500B	8842610
7.375	8.000	.625	.688	31207375-625B	8864910
8.000	8.625	.500	.550	31208000-500B	8866610
8.500	9.125	.625	.688	31208500-625B	8862910

3/8 CROSS SECTION

1.250	2.000	.500	.550	37501250-500B	8842010
1.500	2.250	.500	.550	37501500-500B	8874810
1.500	2.250	.625	.688	37501625-375B	8842710
1.625	2.375	.375	.550	37501500-625B	8901010
1.750	2.500	.500	.550	37501750-500B	8874910
1.750	2.500	.625	.688	37501750-625B	8875010
2.000	2.750	.500	.550	37502000-500B	8875110
2.000	2.750	.625	.688	37502000-625B	8842810
2.250	3.000	.500	.550	37502250-500B	8875210
2.250	3.000	.625	.688	37502250-625B	8842910
2.375	3.125	.625	.688	37502375-625B	8846810
2.500	3.250	.500	.550	37502500-500B	8875310
2.500	3.250	.625	.688	37502500-625B	8843010

$\varnothing d_1$	$\varnothing D_1$	SL	L_1	STD. REF.	PART No.
2.625	3.375	.625	.688	37502625-625B	8863710
2.750	3.500	.500	.550	37502750-500B	8875410
2.750	3.500	.625	.688	37502750-625B	8843110
3.000	3.750	.500	.550	37503000-500B	8875510
3.000	3.750	.625	.688	37503000-625B	8843210
3.125	3.875	.625	.688	37503125-625B	8900310
3.250	4.000	.500	.550	37503250-500B	8875610
3.250	4.000	.625	.688	37503250-625B	8843310
3.375	4.125	.625	.688	37503375-625B	8852110
3.500	4.250	.500	.550	37503500-500B	8875710
3.500	4.250	.625	.688	37503500-625B	8843410
3.625	4.375	.625	.688	37503625-625B	8865310
3.750	4.500	.500	.550	37503750-500B	8875810
3.750	4.500	.625	.688	37503750-625B	8875910
4.000	4.750	.500	.550	37504000-500B	8876010
4.000	4.750	.625	.688	37504000-625B	8843510
4.250	5.000	.038	.550	37504250-375B	8867410
4.250	5.000	.500	.550	37504250-500B	8876110
4.250	5.000	.625	.688	37504250-625B	8843610
4.500	5.250	.500	.550	37504500-500B	8876210
4.500	5.250	.625	.688	37504500-625B	8843710
4.750	5.500	.500	.550	37504750-500B	8876310
4.750	5.500	.625	.688	37504750-625B	8876410
5.000	5.750	.500	.550	37505000-500B	8876510
5.000	5.750	.625	.688	37505000-625B	8843810
5.250	6.000	.500	.550	37505250-500B	8865010
5.250	6.000	.625	.688	37505250-625B	8843910
5.250	6.000	.750	.825	37505250-750B	8854410
5.500	6.250	.500	.550	37505500-500B	8863010
5.500	6.250	.625	.688	37505500-625B	8844010
5.750	6.500	.500	.550	37505750-500B	8866110
5.750	6.500	.625	.688	37505750-625B	8878010
5.875	6.500	.625	.688	37505875-625B	8900410
6.000	6.750	.500	.550	37506000-500B	8866210
6.000	6.750	.625	.688	37506000-625B	8844110
6.250	7.000	.500	.688	37506250-500B	8902410
6.250	7.000	.625	.688	37506250-625B	8844210
6.500	7.250	.500	.550	37506500-500B	8853310
6.500	7.250	.625	.688	37506500-625B	8844310
6.750	7.500	.500	.550	37506750-500B	8854610
6.750	7.500	.625	.688	37506750-625B	8854710
7.000	7.750	.500	.550	37507000-500B	8854010

Rod seals

Hallite 513

inch

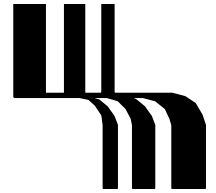
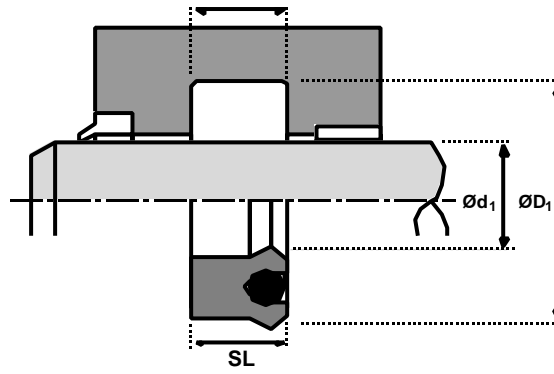

$\text{Ø}d_1$	$\text{Ø}D_1$	SL	L_1	STD. REF.	PART No.
7.000	7.750	.625	.688	37507000-625B	8844410
7.250	8.000	.500	.550	37507250-500B	8865110
7.250	8.000	.625	.688	37507250-625B	8844510
7.250	8.000	.750	.825	37507250-750B	8854510
7.500	8.250	.500	.550	37507500-500B	8863210
7.500	8.250	.625	.688	37507500-625B	8878110
7.750	8.500	.500	.550	37507750-500B	8865210
7.750	8.500	.625	.688	37507750-625B	8853610
8.000	8.750	.625	.688	37508000-625B	8878210
8.250	9.000	.625	.688	37508250-625B	8854110

1/2 CROSS SECTION

1.750	2.750	.750	.825	50001750-750B	8847010
-------	-------	------	------	---------------	---------

$\text{Ø}d_1$	$\text{Ø}D_1$	SL	L_1	STD. REF.	PART No.
2.000	3.000	.750	.825	50002000-750B	8876810
2.500	3.500	.750	.825	50002500-750B	8847110
3.000	4.000	.750	.825	50003000-750B	8863310
4.000	5.000	.750	.825	50004000-750B	8877410
4.250	5.250	.750	.825	50004250-750B	8847210
4.500	5.500	.750	.825	50004500-750B	8847310
5.250	6.250	.750	.825	50005250-750B	8847510
6.000	7.000	.750	.825	50006000-750B	8863410
6.250	7.250	.750	.825	50006250-750B	8847710
7.000	8.000	.750	.825	50007000-750B	8870410
7.250	8.250	.750	.825	50007250-750B	8847810
7.750	8.750	.750	.825	50007750-750B	8847910
8.000	9.000	.750	.825	50008000-750B	8863510